

Snap Intermediates Pvt. Ltd

Product Catalogue



Table Of Content

Product Category : 'Intermediates'	3
Product Names Starting with '#'	4
Product Names Starting with 'A'	6
Product Names Starting with 'M'	7
Product Names Starting with 'N'	8
Product Names Starting with 'P'	9
Product Names Starting with 'T'	10
Product Category : 'Speciality & Fine Chemicals'	11
Product Names Starting with '#'	12
Product Names Starting with 'A'	13
Product Names Starting with 'D'	14
Product Names Starting with 'E'	15
Product Names Starting with 'M'	16
Product Names Starting with 'P'	17
Product Names Starting with 'T'	18
Product Names Starting with 'W'	19



Snap Intermediates Pvt. Ltd

A/304, Kailash Tower, N.S.Phadke Marg, Off.Western Express Highway,Andheri(E), Mumbai-400069,India.

Email : snapintermediates@gmail.com | Website: www.snapintermediates.com | Phone : +(91)-(22)-32257733/ 26846663

Intermediates



Category : Intermediates / Product Names Starting with '#'

1-(4-Chlorobenzhydryl)piperazine

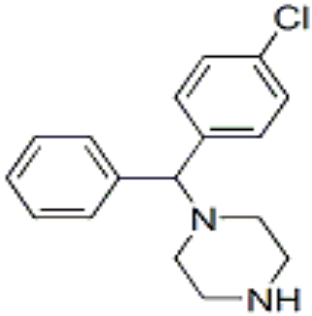

Catalogue Number: 5

CAS: 303-26-4 | **MDL :**

MF: C17H19ClN2 | **MW :** 287

Categories: Intermediates

[Visit Product Page](#)

1H,1,2,4-Triazole

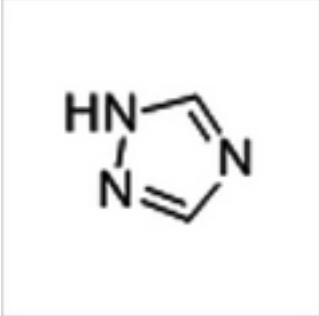

Catalogue Number: 6

CAS: 288-88-0 | **MDL :** NA

MF: C2H3N3 | **MW :** 69

Categories: Intermediates

[Visit Product Page](#)

2,4-Difluoro-alpha-(1H-1,2,4-triazolyl)acetophenone

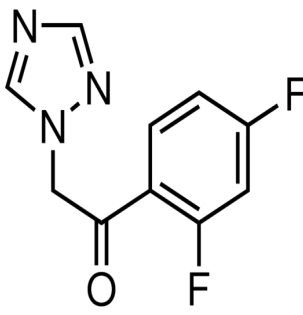

Catalogue Number: 7

CAS: 86404-63-9 | **MDL :**

MF: C10H7F2N3O | **MW :** 223

Categories: Intermediates

[Visit Product Page](#)

2-Mercapto-5-Methoxy Benzimidazole

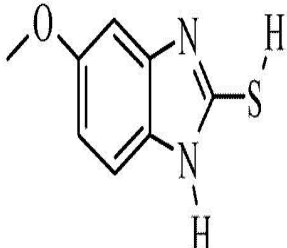

Catalogue Number: 9

CAS: 37052-78-1 | **MDL :**

MF: C8H8N2OS | **MW :** 180

Categories: Intermediates

[Visit Product Page](#)

2-Mercaptobenzimidazole

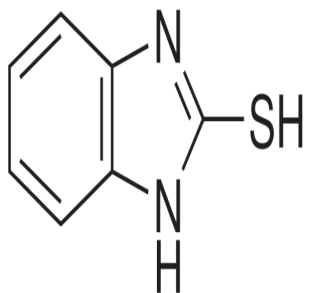

Catalogue Number: 8

CAS: 583-39-1 | **MDL :**

MF: C7H6N2S | **MW :** 150

Categories: Intermediates

[Visit Product Page](#)

3,4-Dimethoxybenzoic acid

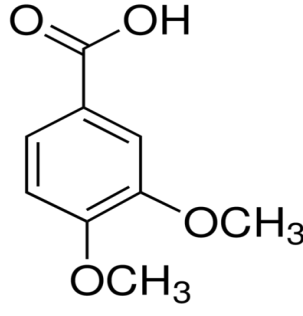

Catalogue Number: 10

CAS: 93-07-2 | **MDL :**

MF: C9H10O4 | **MW :** 182

Categories: Intermediates

[Visit Product Page](#)

3-Bromoanisole

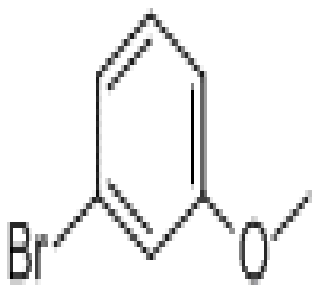

Catalogue Number: 11

CAS: 108-90-1 | **MDL :**

MF: C7H7BrO | **MW :** 173

Categories: Intermediates

[Visit Product Page](#)

3-Methoxysalicylic acid

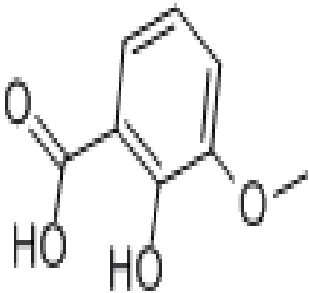

Catalogue Number: 12

CAS: 100-05-1 | **MDL :**

MF: C8H8O4 | **MW :** 160

Categories: Intermediates

[Visit Product Page](#)

4-Nitrobenzenesulfonyl chloride

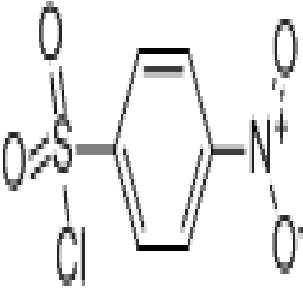

Catalogue Number: 13

CAS: 100-02-7 | **MDL :**

MF: C6H5ClNO2 | **MW :** 171

Categories: Intermediates

[Visit Product Page](#)



Catalogue Number: 13
CAS: 2398-37-0 MDL :
MF: C7H7BrO MW : 187
Categories: Intermediates
Visit Product Page

Catalogue Number: 72
CAS: 877-22-5 MDL : NA
MF: C8H8O4 MW : 168
Categories: Intermediates
Visit Product Page

Catalogue Number: 96
CAS: 98-74-8 MDL : NA
MF: C6H4ClNO4S MW : 222
Categories: Intermediates
Visit Product Page

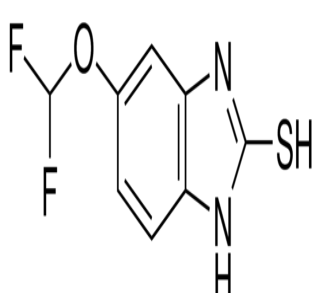
5-(Difluoromethoxy)-2-mercapto-1H-benzimidazole

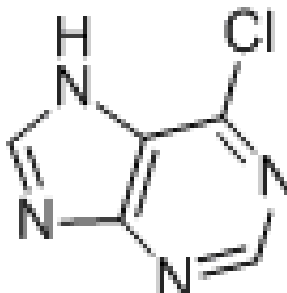
Catalogue Number: 11
CAS: 97963-62-7 MDL :
MF: C8H6F2N2OS MW : 216
Categories: Intermediates
Visit Product Page

6-Chloropurine

Catalogue Number: 1265
CAS: 87-42-3 MDL :
MF: C5H3ClN4 MW : 155
Categories: Intermediates
Visit Product Page

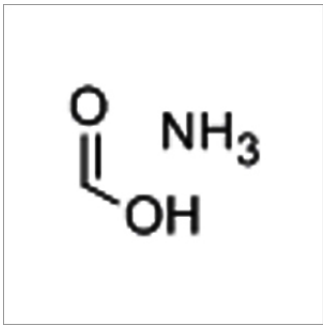

Category : Intermediates / Product Names Starting with 'A'

Ammonium formate

Catalogue Number: 12
CAS: 540-69-2 MDL :
MF: CH5NO2 MW : 63
Categories: Intermediates
Visit Product Page

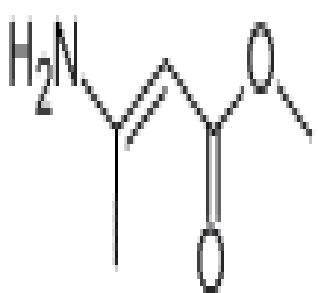

Category : Intermediates / Product Names Starting with 'M'

Methyl 3-aminocrotonate

Catalogue Number: 14
CAS: 14205-39-1 MDL :
MF: C5H9NO2 MW : 115
Categories: Intermediates
Visit Product Page

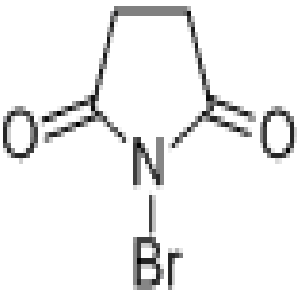

Category : Intermediates / Product Names Starting with 'N'

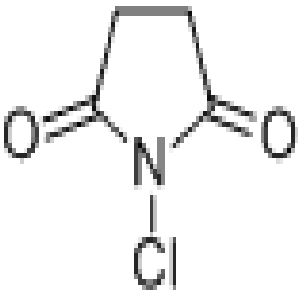
N-Bromosuccinimide

Catalogue Number: 15
CAS: 128-08-5 MDL :
MF: C4H4BrNO2 MW : 178
Categories: Intermediates
Visit Product Page

N-Chlorosuccinimide

Catalogue Number: 16
CAS: 128-09-6 MDL :
MF: C4H4ClNO2 MW : 134
Categories: Intermediates
Visit Product Page

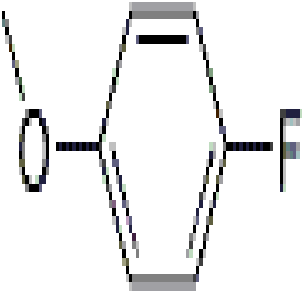

Category : Intermediates / Product Names Starting with 'P'

Para fluoro anisole

Catalogue Number: 17
CAS: 459-60-9 MDL :
MF: C7H7FO MW : 126
Categories: Intermediates
Visit Product Page

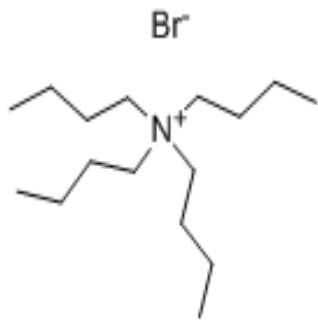

Category : Intermediates / Product Names Starting with 'T'

Tetrabutylammonium bromide

Catalogue Number: 18
CAS: 1643-19-2 MDL :
MF: C16H36BrN MW : 322
Categories: Intermediates
Visit Product Page



Snap Intermediates Pvt. Ltd

A/304, Kailash Tower, N.S.Phadke Marg, Off.Western Express Highway,Andheri(E), Mumbai-400069,India.

Email : snapintermediates@gmail.com | Website: www.snapintermediates.com | Phone : +(91)-(22)-32257733/ 26846663

Speciality & Fine Chemicals

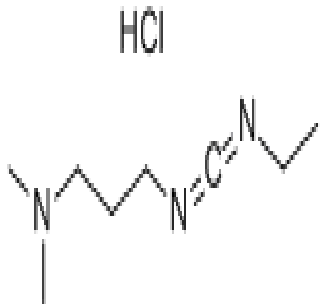

Category : Speciality & Fine Chemicals / Product Names Starting with '#'

1-(3-Dimethylaminopropyl)-3-ethylcarbodiimide hydrochloride
 HCl
Catalogue Number: 19
CAS: 25952-53-8 MDL :
MF: C ₈ H ₁₈ ClN ₃ MW : 192
Categories: Speciality & Fine Chemicals
Visit Product Page

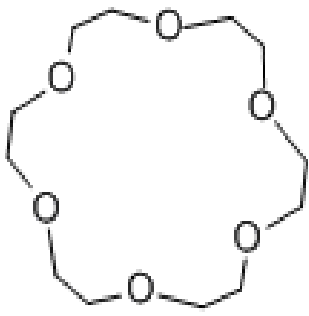
18-Crown-6

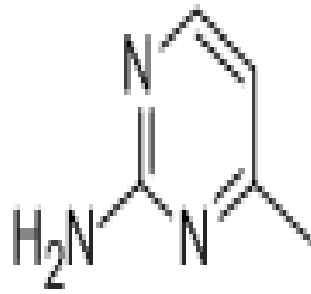
Catalogue Number: 23
CAS: 17455-13-9 MDL :
MF: C ₁₂ H ₂₄ O ₆ MW : 264
Categories: Speciality & Fine Chemicals
Visit Product Page

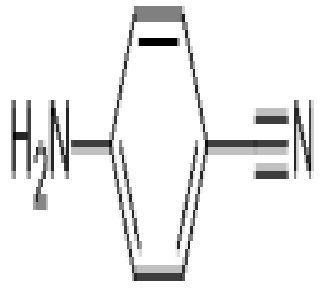
2-AMINO-4-METHYLPYRIMIDINE

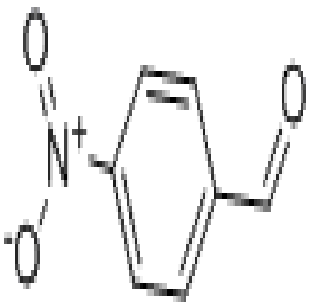
Catalogue Number: 20
CAS: 108-52-1 MDL :
MF: C ₅ H ₇ N ₃ MW : 109
Categories: Speciality & Fine Chemicals
Visit Product Page

4-Aminobenzonitrile

Catalogue Number: 21
CAS: 873-74-5 MDL :
MF: C ₇ H ₆ N ₂ MW : 118
Categories: Speciality & Fine Chemicals
Visit Product Page

4-Nitrobenzaldehyde

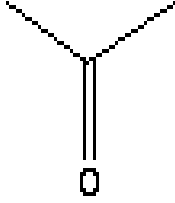
Catalogue Number: 22
CAS: 555-16-8 MDL :
MF: C ₇ H ₅ NO ₃ MW : 151
Categories: Speciality & Fine Chemicals
Visit Product Page



Category : Speciality & Fine Chemicals / Product Names Starting with 'A'

Acetone HPLC,GC,LR Grade

Catalogue Number: 93
CAS: 67-64-1 MDL : NA
MF: C3H6O MW : 58
Categories: Speciality & Fine Chemicals
Visit Product Page

Acetonitrile HPLC,GC,LR Grade
Catalogue Number: 91
CAS: 75-05-8 MDL : NA
MF: C2H3N MW : 41
Categories: Speciality & Fine Chemicals
Visit Product Page

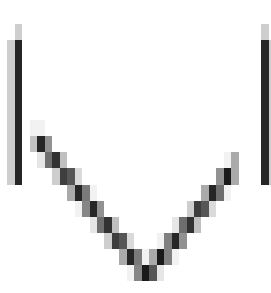

Category : Speciality & Fine Chemicals / Product Names Starting with 'D'

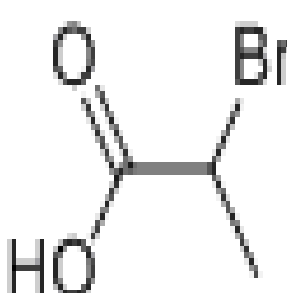
Diodomethane

Catalogue Number: 24
CAS: 75-11-6 MDL :
MF: CH2I2 MW : 268
Categories: Speciality & Fine Chemicals
Visit Product Page

DL-2-Bromopropionic

Catalogue Number: 32
CAS: 598-72-1 MDL :
MF: C3H5BrO2 MW : 153
Categories: Speciality & Fine Chemicals
Visit Product Page

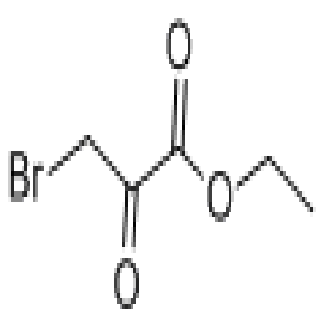

Category : Speciality & Fine Chemicals / Product Names Starting with 'E'

Ethyl bromopyruvate
 <chem>CCOC(=O)C(=O)CBr</chem>
Catalogue Number: 25
CAS: 70-23-5 MDL :
MF: C5H7BrO3 MW : 195
Categories: Speciality & Fine Chemicals
Visit Product Page



Category : Speciality & Fine Chemicals / Product Names Starting with 'M'

Magnesium Filings
Mg
Catalogue Number: 1152
CAS: 7439-95-4 MDL :
MF: Mg MW : 24
Categories: Speciality & Fine Chemicals
Visit Product Page

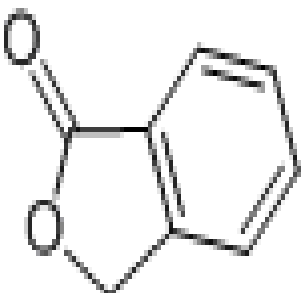

Category : Speciality & Fine Chemicals / Product Names Starting with 'P'

Phthalide

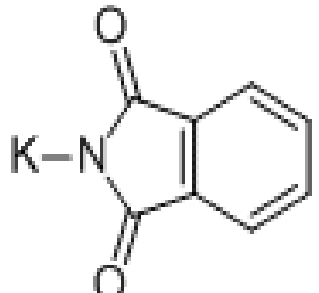
Catalogue Number: 27
CAS: 87-41-2 MDL :
MF: C ₈ H ₆ O ₂ MW : 134
Categories: Speciality & Fine Chemicals
Visit Product Page

Potassium phthalimide

Catalogue Number: 28
CAS: 1074-82-4 MDL :
MF: C ₈ H ₄ KNO ₂ MW : 185
Categories: Speciality & Fine Chemicals
Visit Product Page

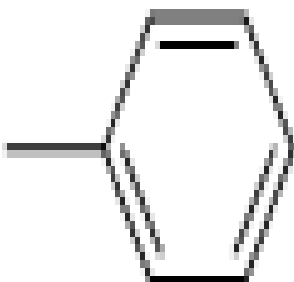

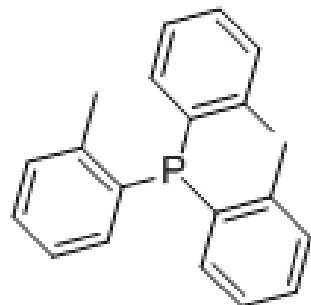
Category : Speciality & Fine Chemicals / Product Names Starting with 'T'

Toluene HPLC,GC,HR grade

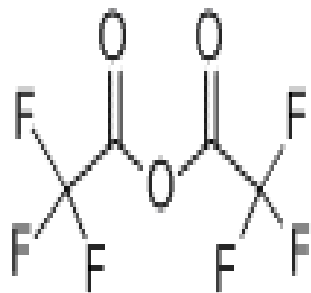
Catalogue Number: 92
CAS: 108-88-3 MDL : NA
MF: C6-H5-CH3 MW : 92
Categories: Speciality & Fine Chemicals
Visit Product Page

TRI-O-TOLYLPHOSPHINE

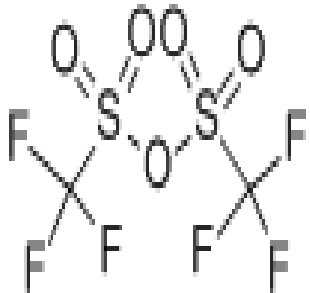
Catalogue Number: 31
CAS: 6163-58-2 MDL :
MF: C21H21P MW : 304
Categories: Speciality & Fine Chemicals
Visit Product Page

Trifluoroacetic anhydride

Catalogue Number: 29
CAS: 407-25-0 MDL :
MF: C4F6O3 MW : 210
Categories: Speciality & Fine Chemicals
Visit Product Page

Trifluoromethanesulfonic anhydride

Catalogue Number: 30
CAS: 358-23-6 MDL :
MF: C2F6O5S2 MW : 282
Categories: Speciality & Fine Chemicals
Visit Product Page



Category : Speciality & Fine Chemicals / Product Names Starting with 'W'

Water HPLC,GC,LR Grade
Catalogue Number: 94
CAS: 7732-18-5 MDL : NA
MF: H2O MW : 18
Categories: Speciality & Fine Chemicals
Visit Product Page